

TO-220-3L Plastic-Encapsulate Transistors

FEATURES

- Medium Power Complementary Silicon Transistors
- Darlington TRANSISTOR (NPN)

MECHANICAL DATA

- Case style:TO-220-3L molded plastic
- Mounting position:any

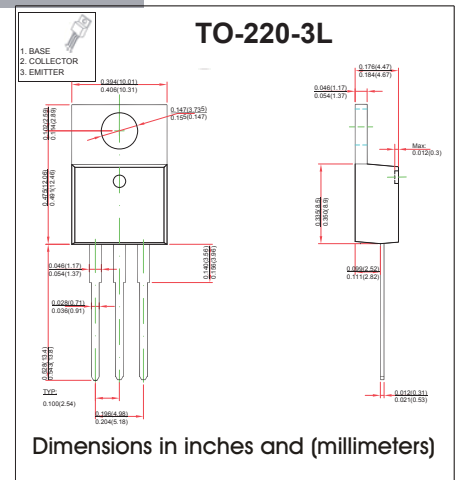

MAXIMUM RATINGS AND CHARACTERISTICS

@ 25°C Ambient Temperature (unless otherwise noted)

Symbol	Parameter	TIP121	Unit
V_{CBO}	Collector-Base Voltage	80	V
V_{CEO}	Collector-Emitter Voltage	80	V
V_{EBO}	Emitter-Base Voltage	5	V
I_C	Collector Current -Continuous	5	A
P_C	Collector Power Dissipation	2	W
$R_{\theta JA}$	Thermal Resistance Junction to Ambient	62.5	°C/W
$R_{\theta Jc}$	Thermal Resistance Junction to Case	1.92	°C/W
T_J	Junction Temperature	150	°C
T_{stg}	Storage Temperature	-55to+150	°C

ELECTRICAL CHARACTERISTICS ($T_a=25^\circ\text{C}$ unless otherwise specified)

Parameter	Symbol	Test conditions	Min	Max	Unit
Collector-base breakdown voltage	$V_{(BR)CBO}$	$I_C=1\text{mA}, I_E=0$	60 80 100		V
Collector-emitter breakdown voltage	$V_{CEO(SUS)}$	$I_C=30\text{mA}, I_B=0$	60 80 100		V
Collector cut-off current	I_{CBO}	$V_{CB}=60\text{V}, I_E=0$ $V_{CB}=80\text{V}, I_E=0$ $V_{CB}=100\text{V}, I_E=0$		0.2	mA
Collector cut-off current	I_{CEO}	$V_{CE}=30\text{V}, I_B=0$ $V_{CE}=40\text{V}, I_B=0$ $V_{CE}=50\text{V}, I_B=0$		0.5	mA
Emitter cut-off current	I_{EBO}	$V_{EB}=5\text{V}, I_C=0$		2	mA
DC current gain	$h_{FE(1)}$	$V_{CE}=3\text{V}, I_C=0.5\text{A}$	1000		
	$h_{FE(2)}$	$V_{CE}=3\text{V}, I_C=3\text{A}$	1000		
Collector-emitter saturation voltage	$V_{CE(sat)}$	$I_C=3\text{A}, I_B=12\text{mA}$ $I_C=5\text{A}, I_B=20\text{mA}$		2 4	V
Base-emitter voltage	V_{BE}	$V_{CE}=3\text{V}, I_C=3\text{A}$		2.5	V
	C_{ob}	$V_{CB}=10\text{V}, I_E=0, f=0.1\text{MHz}$		300 200	pF